



● Statement

The Easiprox stand-alone proximity reader is a low cost programmable access control system based on the EM400x proximity tags and cards. The unit is rated IP67 and can be installed in an outdoors location. The system can store the codes of 2000 unique tags. Adding and deleting tags is done by simple use of a Master Tag. The optional Tag Simulator / Programming Unit allows the programming (adding & deleting) of lost tags. The Relay can operate in Pulse or Toggle mode.

● Specifications

- Operating Voltage: 12 Vdc or ac .
- Current Draw: Average 45mA , Peak 70 mA @ 12 V DC
- Input: request-to-exit, read head.
- Relays Electric Current: 3A MAX @24Vdc .
- Memory Volume: 2000 Proximity cards/tokens .
- Proximity Cards: 125 KHz, EM-400x, 64-bit standard R/O
- Read Range : 10~15 cm (Depending on local installation Conditions)
- Case Material: ABS (UL94V0)
- Operating Temperature: -20~+70°C
- Ambient Humidity: 5~95% relative humidity non-condensing
- Visual Signals:
 - Yellow: Power on
 - Green: Add Tags
 - Red: Delete Tags
 - Yellow/Red: Clear Memory
 - Yellow(flashing): strike mode and timer adjust
- EPROM:Non-volatile memory, System will retain all programs and codes after a total loss of power.
- Output: Dual relay, N.O. / N.C. / Com. Output (free voltage contact)
- Relocking Timer: 0.7~42 seconds
- Colour: Dark gray
- Dimension: (L)86*(W)86*(D)21 mm (for Common Europe single-gang box sized)

● Dimension

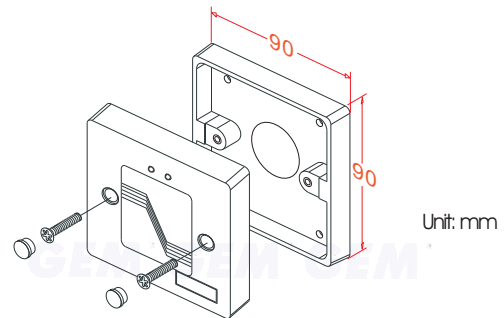

● System Features



2,000 cards holder registration provides a powerful extended range for common community application.

Master Card

Field proven unique Master card to add or delete cards holder gives the minimized in convenience of numeric PIN codes password. and extra computer literacy.



IP67 Rating stands against extremely heavy weather condition while keypad-free configuration always leads no vandalistic.

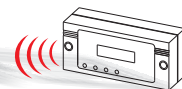

Optional implement, **TS-980** simulator runs to rise satisfactory of cards holder management facilitation.

GIANNI INDUSTRIES, INC.

No.306-1, Hsin Shu Road, Hsin Chuang, Taipei,Taiwan 242
 TEL: 886-2-2206 9929 FAX: 886-2-2204 6632
 E-Mail: info@gianni.com.tw
 Website: gianni.tw



The products are manufactured under an ISO 9001 & QC 080000 Certified Quality Management Program environment back its product quality, performance and commitment to customer satisfaction.

● Easy Programming

ADD state

Read the Master Tag once

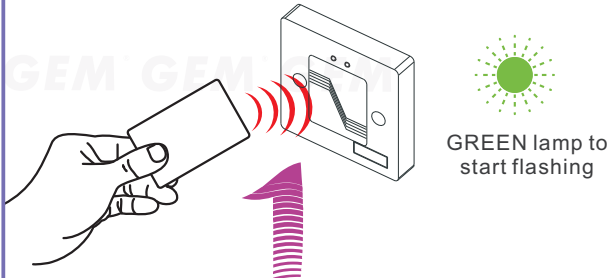

GREEN lamp to start flashing

Delete Tags

Read the Master Tag twice

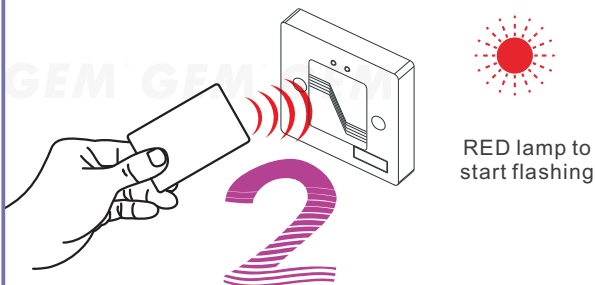

RED lamp to start flashing

Clear Memory

Read the Master Tag three times

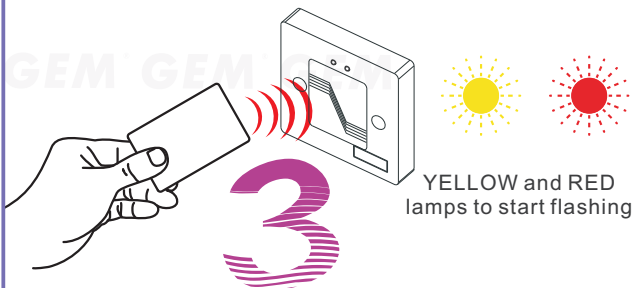

YELLOW and RED lamps to start flashing

Time Adjust and Toggle Mode Selection

Read the Master Tag four times

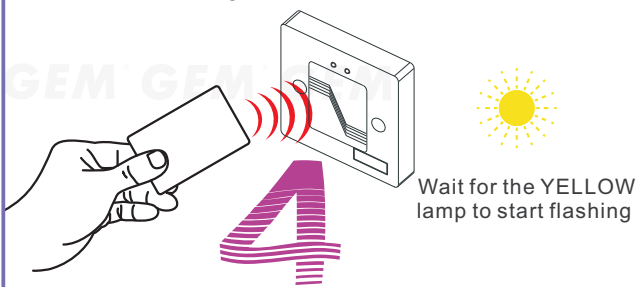

Wait for the YELLOW lamp to start flashing

● Optional Accessory

The Tag Simulator is used to add and delete any card/tag number from the reader memory when the tag is lost or not available.



TS-980 simulator

- Unit size : 120 L x 54 W x 38 H mm
- Weight : 180 g
- Operating distance : less than 60 mm
- Battery : PP3 - 9V

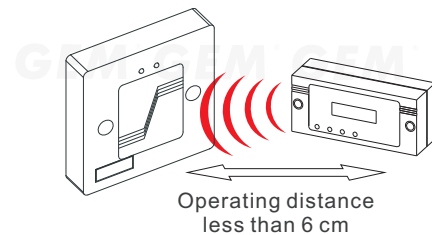

Operating distance less than 6 cm

● Warranty

The product is warranted against defects in material and workmanship while used in normal service for a period of 1 year from the date of sale to the original customer. The GEM policy is one of continual development and improvement; therefore GEM reserves the right to change specifications without notice.

GIANNI INDUSTRIES, INC.

No.306-1, Hsin Shu Road, Hsin Chuang, Taipei, Taiwan 242
 TEL: 886-2-2206 9929 FAX: 886-2-2204 6632
 E-Mail: info@gianni.com.tw
 Website: gianni.tw